

AS 43, AS 45, AS 200 IT



## Safety Notes

- Installation and Maintenance of the System only by trained personnel.
- Important! To prevent personal injury and damage to equipment please ensure that the system is properly earthed and that the appropriate cable is connected in the mains plug.
- The System must be installed horizontal so that the connection panel is on the right hand side.
- Do not connect or disconnect any PSTN lines during a thunderstorm.
- Install lines and extensions in such a way that no one walks or trips over them.
- Disconnect the System from the mains supply before opening the connection panel.  
Before connection of lines and extensions please ensure that the system is unplugged from the mains supply. DANGER!
- Preventive measure! Before carrying out any installation work, please touch briefly the PC/ Printer socket of the telephone system. This will discharge any possible electrostatic charges, thus protecting the telephone system's electrostatically sensitive components.
- Do not allow liquids to enter the system as short-circuits may occur.
- No liability will be accepted for consequential damages such as an unintentional continued connection of a line.
- The telephone system will not operate in case of power failure and you will not be able to make any type of call.

The AS 43, AS 45 and AS 200 IT can be connected to Basic Rate ISDN lines (DSS1, Point to Point, System Access, or Point to Multi Point, Standard Access) and may also be connected to analogue exchange lines.

Should you operate your PBX-System on an analogue exchange line, then please ensure that your telephone service provider has meter pulse sending disabled as this may otherwise interfere with speech quality of a call.

You may connect any equipment which has been approved for the connection to the Public Switched Telephone Network (PSTN) to the extension port of the system.

Any DSS1 ISDN device which has been approved for the connection to the ISDN telephone exchange may be connected to the internal SO Bus. In addition you may connect up to two digital AGFEO System Phones to each SO Bus.

Any other use of the telephone system which is not listed or described is prohibited.

The telephone system has been issued with a universal connection licence.

The system fulfils the specified conformity and safety regulations.

## Table of contents

Safety Notes .....	2
Check contents of delivery .....	4
Open Connection Cover .....	5
Closing Connection Cover .....	5
LEDs of the AS 43, AS 45 .....	7
Installing and replacing modules .....	8
Installation of AS 200 IT .....	8
The K-Module 524 .....	9
Switchable S0 Connections .....	10
Short and Extended Passive Bus Internal S0 Bus configuration .....	13
T-Module 508 .....	14
S0-Module 540 .....	15
Up0-Module 508 .....	16
AL-Module 4504 .....	17
Differences to an ISDN Line .....	17
CLIP at the Analogue Exchange .....	17
K-Module 544 .....	19
System Interconnection .....	20
Commissioning .....	21
Technical Data .....	22

# AS 43, AS 45, AS 200 IT

## Check contents of delivery

- 1 Telephone System
- 1 Installation material (3 Wall Plugs S6,3 Wood Screws,Phillips 4x40)
- 1 RS 232 PC connection Cable
- 1 USB Connection Cable
- 1 Template
- 1 Instructions Pack
- 1 CD-ROM with TK-Suite and the AIS Konfigurator

The operating instruction in PDF format can be found on our homepage [www.agfeo.de](http://www.agfeo.de)

## Select Location

Install the System in a dry room free of any hazardous materials. Avoid sites near Air Conditioners, Radiators, Equipment with excessive high radiation, direct sunlight, excessive dust and the danger of liquid spillages such as Water or Chemicals. Ambient Temperature 5C to 30 C. Max humidity 70% non condensing. The distance of the equipment to other objects such be considered to guarantee an air circulation. The minimum clearance distance of 50 cm should be adhered to. The distance of the system to the mains socket and the telephone network socket should not be more than 1 meter. (Length of mains cable 1.20 m)  
It must be made possible to place a Laptop or PC near the telephone system for programming.

## Mains Socket

A separate mains socket for the telephone system should be installed. This will assist to give uninterrupted service in case that a mains fuse is tripped. The power consumption of the telephone system is approx 50 VA.  
Please ensure that the system cover is replaced before connecting the equipment to the mains.

Warning! The telephone system must be electrically earthed. Please ensure that the mains socket is properly earthed before connecting the equipment to it.

# AS 43, AS 45, AS 200 IT

## Open Connection Cover

**Please unplug the telephone system from the 230 Main Socket before opening the cover.**

1. Insert a screwdriver in the opening of the cover and press the screwdriver in the direction of the arrow.
2. Open the lid in the direction of the arrow.

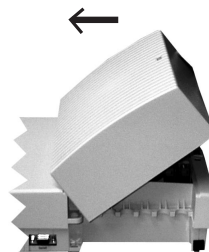
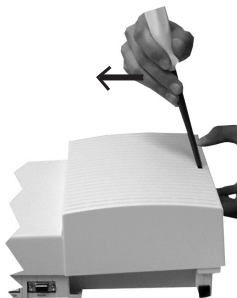

3. Open the lid fully as shown in the picture.

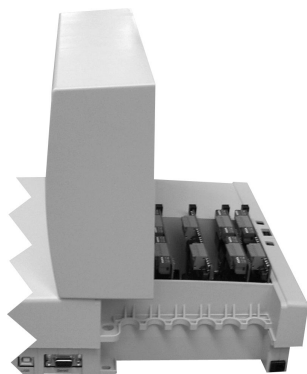

4. Remove lid in the direction of the arrow.



## Closing Connection Cover

1. Insert carefully curved hinge into the designated catch.
2. Turn the lid in such a way that the straight hinge will fit into the designated catch.
3. Close the lid with light pressure until you hear the ratchet click into place.

# AS 43, AS 45, AS 200 IT

## Wall mounting

The system must be mounted on the wall so that the connectors are at the bottom of it. Use the mounting 1, 2, and 3 to fix the equipment to the wall.

- Use the template to mark the screw position.
- Before drilling ensure that there is no Mains, Water or Gas supply hidden in the wall.
- Use a masonry drill bit of 6 mm and drill to a depth of 40 mm,  
or
- Wood Drill 3.5 mm Drill Depth 35 mm
- Insert Wall Plug and Screw, Screwhead distance from wall approx 3 mm.--
- Place the system on top of the screws and pull downwards until in place.
- Use last screw to secure system to wall.

## Moduleslots of the AS 43, AS 45

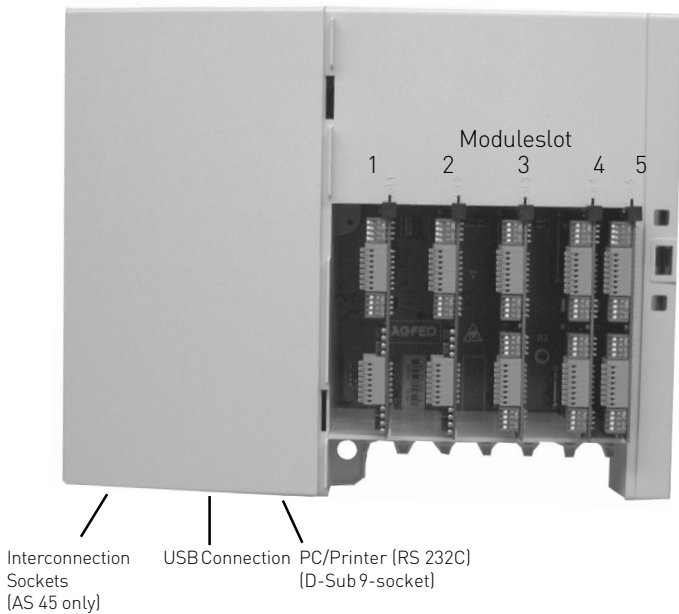

### Notes:

The AS 43 offers moduleslots 1-3 only!

# AS 43, AS 45, AS 200 IT

## LEDs of the AS 43, AS 45

- LED 1
- LED 2
- LED 3
- LED 4

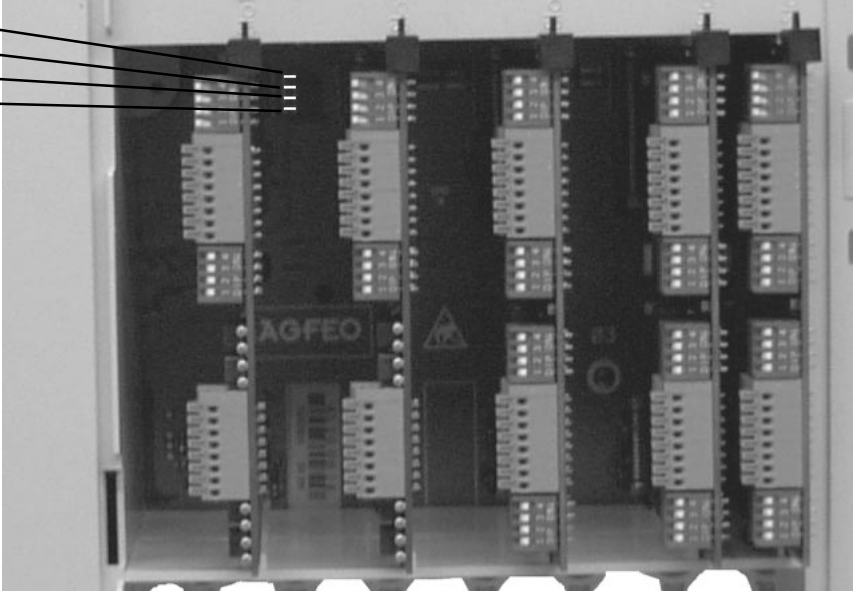

### Permanently Lit

### Flashes

#### LED 1 (red)

System is operational

System being initialised

#### LED 2 (green)

Data being transferred

#### LED 3 (green)

System is connected to the computer via USB

USB Activity

#### LED 4 (green)

Interconnection Active  
(AS 45 only)

Interconnection not synchronised  
(AS 45 only)

# AS 43, AS 45, AS 200 IT

## Safety Notes

Pay attention to the safety notes

- before installing or removing a module,
  - before connecting or disconnecting a connecting lead
1. Remove the telephone system's 230 V mains plug from the socket.
  2. Remove the Western plugs of all external ISDN basic accesses from the telephone system, the network terminator (NT) or the S0 bus.
  3. Touch the metal shield of the PC/ printer socket on the bottom of the telephone system briefly with your finger. This will discharge any possible electro static charges, thus protecting the telephone system's electrostatically sensitive components.

## Installing and replacing modules

### Installing a Module

- Insert the module vertically, with the large connector strip pointing upwards, into the top hand bottom guide slits of one slot.
- Carefully push the module down until the connectors engage and the latching lug of the module latches into the lock.
- Pull the adhesive label showing the module's connections off the information sheet (included with the module packaging).
- Stick the adhesive label over the module's slot on the housing.

### Replacing a Module

- Undo the module's connecting leads. Mark the connecting leads clearly to avoid confusion on reconnection.
- Press the lock upwards until the module's latching lug is free. Carefully pull the module out towards you.
- Install the new module as described before.

## Installation of AS 200 IT

Instructions on how to open an AS 200IT, installation of modules and patchfield are available in the installation instruction of the AS 200 IT, Ref. Nr. 1101331



## The K-Module 524

### Connections:

- 2 SO connections switchable internal / external (external: PTP or PTMP internal: PTMP)
- 4 Analogue Extensions (POT's)

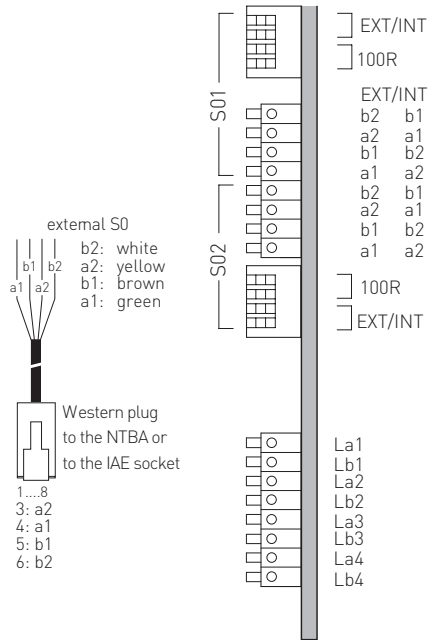

### Connect Analogue Extensions

You may connect any analogue apparatus to the system which has been approved for connection to the public switched telephone network.

#### a/b-Apparatus is:

- Telephone (2 wire Phone or POT) either LD or MF Dialling with Timed Break Recall (TBR) (60 – 800 ms)
- LD Phones may only have limited feature access.
- Fax machines Group 3
- Telephone Answering Machines
- Modem 56k (V.90 to 56600 bps, may reduce to 33600 bps due to quality of lines V.34+)

Connect the analogue apparatus via 2 wires to the a and b wire (Speech Pair) of the system port

#### Connection of wire:

- Strip the cable by 11 mm.
- Push the single wire all the way into the connection block without pressing the release catch.
- To disconnect a wire, press the release catch with a small screwdriver while at the same time pulling out the conductor

## Switchable S0 Connections External S0 Connections

### External S0-Connection

You may connect the external S0 Connection to a System Access (PTP) or Standard Access (PTPM) line. Please refer to External S0 Connection (RJ45 Socket).

Use the enclosed ISDN Cable and connect the four wires to the S0 connection block of the module.

- Push the wire all the way into the connection block without pressing the release catch.
- Connector: a1 -green  
                  b1 -brown  
                  a2 -yellow  
                  b2 -white
- To disconnect a wire, press the release catch with a small screwdriver while at the same time pulling out the conductor.
- Guide the cable through the cable comb.

Termination Resistors for the external S0 Connection

### System Access (PTP)

- Both DIP Switches for the 100 Ohm Resistors must be closed or set to on. (Default Setting)

**Standard Access (PTMP)** - Both DIP Switches (Page 1-7/8) must be

- **closed or set to on** if the connection is made directly onto the NTTP or on the last socket which has no 100 Ohm Termination Resistors fitted.
- **open or set to off** if the last socket has the 100 Ohm Termination Resistors installed or if the telephone system is not the last ISDN device on a PTMP line.

Plug the ISDN Plug into the ISDN connection after completion of all installation work.

# AS 43, AS 45, AS 200 IT

## Internal S0 Connections

You can connect up to 8 ISDN devices like on a PTMP connection on the internal S0 Bus of the System.

ISDN Apparatus:

Digital AGFEO System Phones (max 2 digital phones per S0 Bus)

-ISDN -Telephones

-ISDN -PC-Cards

-ISDN -Fax machines

Up to four ISDN devices without additional power may be connected. For example: 4 ISDN Telephones or 2 Digital System Phones plus 2 ISDN Telephones.

Connections of further ISDN devices will need their own power source.

ISDN Apparatus must use the DSS1 protocol.

You will need the following material to install an internal S0 Bus.

Telephone wire CW1308 (minimum 2 pair) or CAT5 Cable

RJ45 Sockets max. 12 per Bus

2 Termination Resistors, 100 Ohm 0.25 W

Maximum S0 Bus length will be 130 m. (Telephone System to last RJ45 Socket)

### Termination Resistors for the Internal S0 Connection

The internal S0 Bus must be terminated. Install two 100 Ohm Resistors in the last RJ45 Socket (See Diagram). Both DIP Switches must be closed (or set to on)

Colour Code for Telephone Cable CW1308

S0 Bus	Contact	Colour
a1	4	Blue/white Bands
b1	5	White/Blue Bands
a2	3	White/Orange Bands
b2	6	Orange/White Bands

Colour Code for T568B (CAT5)

S0 Bus	Contact	Colour
a1	4	Blue/White
b1	5	White/Blue
a2	3	White/Green
b2	6	Green/White

Colour Code for T568 A (ISDN)

S0 Bus	Contact	Colour
a1	4	Blue/white
b1	5	White/Blue
a2	3	White/Orange
b2	6	Orange/White

Most common used standard for S0 Bus installation is T568B (CAT5)

Ensure that pairs are not mixed up.

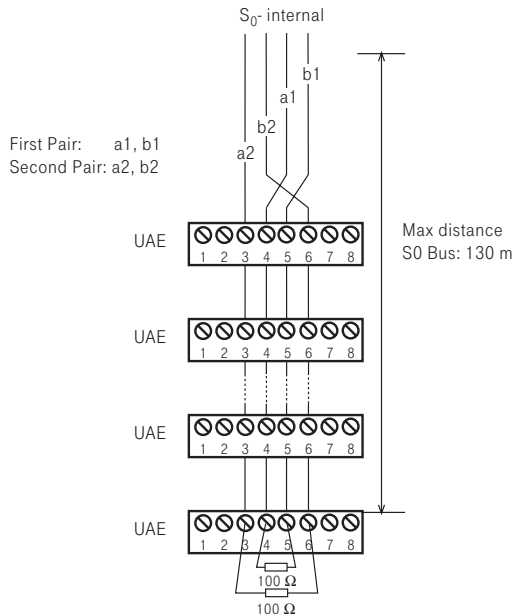

## Installation and Termination of the S0 Bus

It is important that the S0 Bus will be terminated with 100 Ohm resistors on the end of the line. Without termination the signals will be reflected on the line end and returned - similar to water when this hits an obstruction. The reflected signals will collide with the next received signals and destroy these. The result is that the S0 Bus will become faulty. Even though with the termination of four 100 Ohm resistors on either end of the "receive" and "transmit" circuit it may look as if the line is under heavy load but the resistors will have hardly any influence on the signalling voltage. A point to point installation will be terminated at the NTTP and the Telephone System itself, it will be imperative that with a Bus installation the line will always be terminated at the end of the circuit. Also, it is important that the line which is transmitting to the exchange is not reversed between sockets. As the signals have positive and negative pulses, a telephone which is sending positive signals may be received as negative on the other phone and may delete the positive impulses of that phone. The result will be that the S0 Bus will become faulty.

## Fault description and possible causes

### **Calls a dropped. Intermittent fault.**

- Check the connection between telephone system and the connected sockets / distribution points.
- Check that cables are correctly terminated. If possible use a meter and start at the system end. The exchange, the internal S0 Bus and all connected apparatus must be disconnected before measuring the line.
- Most cases will show a loose connection. Disconnect the cable from the system and socket and then reconnect.

### **Only one apparatus at a time will function on the Bus.**

- Please check that the wires between sockets are not reversed. If this is the case then one device will function. However, more than one device will cause interference between each other.

### **High interference, instable lines, crackling in handset.**

- If the system is not operated via a plug in power supply, then it will be earthed via mains supply. Heavy interferences via earth can lead to crackling and even disconnection of calls. In order to establish if an earth problem exists, experiment and disconnect the earth momentarily or use an insulation transformer.

### **Interferences from other devices**

- Some devices such as mechanical bells have a large interference potential and can lead to call disconnection.

## Short and Extended Passive Bus Internal S0 Bus configuration

Some technical aspects should be observed on the installation of an ISDN Bus and may require different settings. The telephone system is sending impulses in a specific "frame". The telephone exchange is expecting an answer of these frames from the connected telephone and devices. The time until an answer is received will vary and is depending on the cable length. The longer the cable the later the reply will be. The signal has to go through the cable twice (there and back). Due to this a important requirement should be observed.

The telephones should not be too far apart that due to the running time of the signal the first bit of the distant phone will not coincide with the second bit of the nearer phone. Due to this the receiver of these bits cannot be separated and the transmission will malfunction. Due to this two different Bus settings may be selected.

### Extended Passive Bus ( 0 to 1000 Metres)

In this operation the receiver will search for the beginning of a receiving frame. With this it is able to adjust to a phone which is near and has a short running time and to a phone which is far away and has a long running time. Both at the same is not possible. On the contrary the search mode is very sensitive. Due to this the phone can only be apart for a maximum of 50 metres to ensure that the impulses will be near to equal timing. This could be 400 metres and 450 metres or 25 and 75 metres.

### Short Passive Bus ( 0 to 130 Metres)

The restriction of 50 metres between telephones on a bus installation is not always possible. Due to this there is a second operational mode. In this mode the search facility is switched off. The receiver is expecting the time frame in a specified time window. This window is relative large and allows for a distance between telephones from 0 to 130 metres. For example a telephone may have a distance of 5 metres and another one of 130 metres from the exchange or telephone system. The maximum distance of a device to the exchange should not exceed 130 metres. However, this will also depend on the cable used. This mode is to be suggested for star wiring installation.

You will find this option in the remote configuration tool in the "Option internal S0"

# AS 43, AS 45, AS 200 IT

## T-Module 508

The T Module 508 features 8 interfaces for analogue extensions. This module supports the CLIP function.

You may connect any analogue apparatus to the system which has been approved for connection to the public switched telephone network.

### a/b-Apparatus is:

- Telephone (2 wire Phone or POT) either LD or MF Dialling with Timed Break Recall (TBR) (60 – 800 ms)
- LD Phones may only have limited feature access.
- Fax machines Group 3
- Telephone Answering Machines
- Modem 56k (V.90 to 56600 bps, may reduce to 33600 bps due to quality of lines V.34+)

Connect the analogue apparatus via 2 wires to the a and b wire (Speech Pair) of the system port

### Connection of wire

- Strip the cable by 11 mm.
- Push the single wire all the way into the connection block without pressing the release catch.
- To disconnect a wire, press the release catch with a small screwdriver while at the same time pulling out the conductor

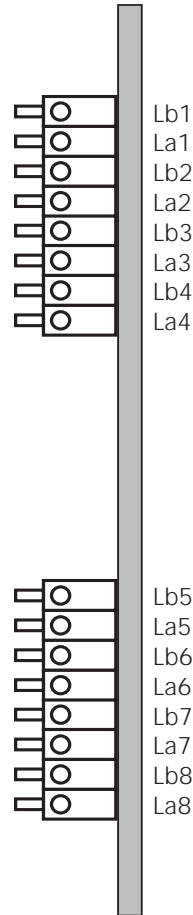

# AS 43, AS 45, AS 200 IT

## S0-Module 540

The S0 module features the following interfaces:  
4 Switchable internal / external S0 interfaces

**external:** ISDN basic access as a point-to-multipoint or point-to-point connection

**internal:** point-to-multipoint connection

### Switching to an internal S0 access

Set both DIP-switches "ext./int." of the respective S0 access to "int."-position (ON).

### Switching to an external S0 access

Set both DIP-switches "ext./int." of the respective S0 access to "ext."-position.

### Terminators (100 Ohm)

Activate - set both DIP-switches "off/on" of the respective S0 access to "on"-position (ON). Deactivate - set both DIP-switches "off/on" of the respective S0 access to "off"-position.

See Page 10 to 13 for further hints for a correct termination of an external or internal S0 access.

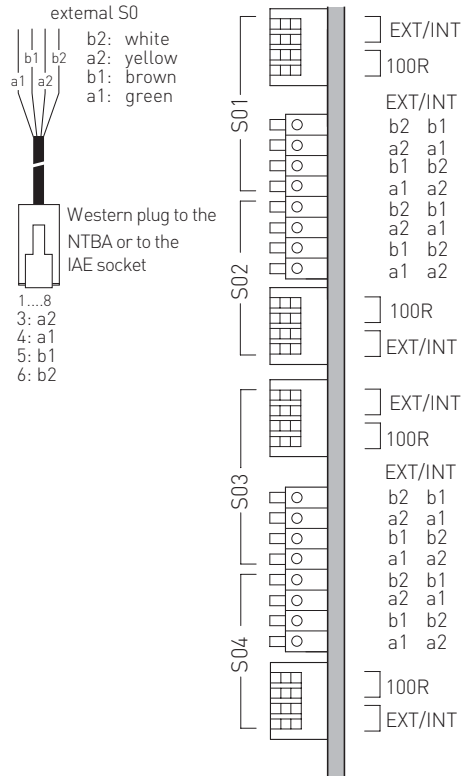

## Up0-Module 508

The UP0-Module 508 can support of up to eight AGFEO Up0 System Telephones. Please note that in order to operate an Up0 Module it will be imperative that a system firmware from 7.5 is installed.

### Connections of Extensions:

- Strip the cable by 11 mm.
- Push the single wire all the way into the connection block without pressing the release catch.
- To disconnect a wire, press the release catch with a small screwdriver while at the same time pulling at the wire.
- The wires are to be connected to contact 4 and 5 of the socket.
- The Up0 Module is NOT polarity conscious.
- Please note you can only connect 1 apparatus to each Up0 connection. A termination resistor is NOT required.

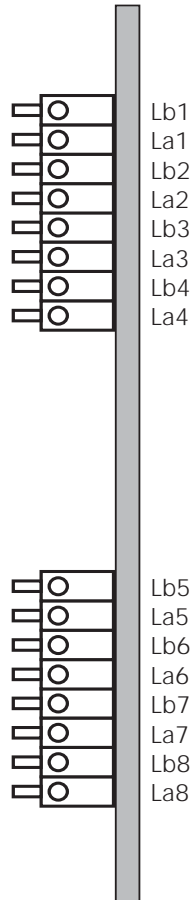



# AS 43, AS 45, AS 200 IT

## AL-Module 4504

You may connect up to 4 analogue exchange lines to this module. The module supports DTMF dialling and CLIP, however the latter would have to be enabled by your network operator and may be chargeable. Should your network operator support CLI, then this will be presented via the AL4504 module to the system. CLIP\* will also be entered into the call log and call management system. [\*CLIP (Calling Line Identity Presentation) is a feature which will display the telephone number and or name of the calling party before you answer the call.]The PABX compares the received CLIP information with the entries of the system telephone book and if a match is found will replace the calling telephone number with the name as it is entered in the system telephone book. This information will also be used by the call log and call management system. CLI will also be presented to analogue caller id telephones. If necessary the AL4504 can be updated.

## Differences to an ISDN Line

Unlike to the protocol based ISDN line, the apparatus connected to the analogue line will not receive a call progress report from the telephone network. For instance the connected device on an analogue line will not receive a confirmation that the called party has answered the call. This will result in the following difference between an analogue exchange line and an ISDN line:

The moment the exchange line has been seized is the time the call will be logged as to have taken place. TK Suite Bill will log a call as being completed or have taken place as soon as an exchange line has been seized, even if the line is still ringing or engaged. MF over dialling is possible but will not be recognised by the system as such. This will result that the complete telephone number and over dialled number will be stored in the call log and last number redial.

## CLIP at the Analogue Exchange

In default the PABX is set that an incoming call will ring an extension without using the CLIP function. However, you may enable this function by changing the setting in 'Wait for CLIP'. The forwarding of the CLIP information from the telephone network may take up to 5 seconds, during this time the system will be idle. Therefore the extensions will ring with a delay of up to 6 seconds. It may be useful to make use of the function 'Wait for CLIP' if this information will not be displayed at your extension, or if you use a call filter or SMS messaging via the analogue line.

## Notes

Further installation and programming information of the AL Module 4504 are available the installation instruction of the AL-Module 4504, Ref. Nor. 1100692.

# AS 43, AS 45, AS 200 IT

## Important Notes

Remote programming and Remote Updating of the PABX and or AL Module 4504 will not be possible when using an analogue exchange line only.  
The AL-Module 4504 DOES NOT support meter pulses from the exchange. To avoid malfunction, please ensure that meter pulses are disabled from the relevant telephone provider.

## Connection of Analogue Lines

Connecting the wires:

- Strip 11 mm of insulation from the wires.
- Slide the individual wires into the clip up to the insulation without pressing the spring clip.
- Push
- To release a wire, press the spring clip down using a suitable object (small screwdriver) and pull out the wire.

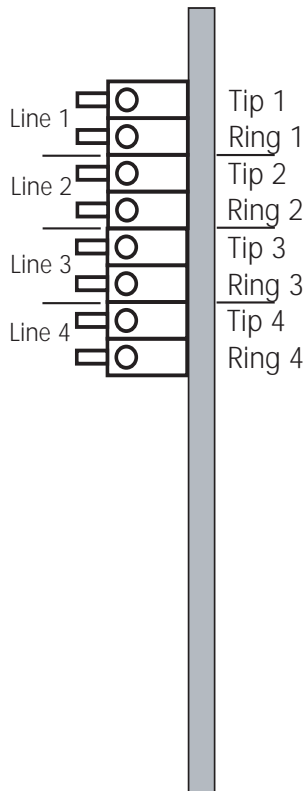

# AS 43, AS 45, AS 200 IT

## K-Module 544

The AGFEO K-Module 544, is for the Telephone Systems AS 43, AS 45 and AS 200 IT from firmware 7.1 and will support the following three communications sections. These are:

### Alarm Section:

4 alarm input contacts with independent voltage supply + 12 V 250 mA

































### Door Phone Section:

3 Analogue Extensions (SLT) with CLIP for analogue phones, fax machines or AGFEO Door Phones. With 2 Switching Relays.

### Audio Section:

Audio input with a 3.5 mm socket for MoH and background music. Audio output with symmetrical 0.8 Watt/8 Ohm for loudspeakers, switchable as pre-amp output (asymmetrical) for an external amplifier.

## Connections of K-Module 544

	AL 1 IN	Signalling Input Sensor 1	
	AL 1 -	Ground	
	AL 2 IN	Signalling Input Sensor 2	
	AL 2 -	Ground	
	AL 3 IN	Signalling Input Sensor 3	
	AL 3 -	Ground	
	AL 4 IN	Signalling Input Sensor 4	
	AL 4 -	Ground	
	AL +	12V Supply Voltage	
	AL +	12V Supply Voltage	
	U-1	Transformer for Dooropener for doorphone with 2-wire-standard connection	
	U-2		
	La1	Extension 1/ Doorphone Connection for doorphone with 2-wire-standard connection	
	Lb1		
	La2	Extension 2/ Doorphone Connection for TFE FTZ 123 D 12	
	Lb2		
	La3	Extension 3/ analogue 2-wire doorphone [e.g., AGFEO TFE 2/4]	
	Lb3		
	KT 1	Bell Push for FTZ 123 D 12	
	KT 2		
	TO 1	TO for TFE FTZ 123 D 12	
	TO 2		
	TS 1	TS for TFE FTZ 123 D 12	
	TS 2		
	REL 1-1	Switching Relay 1	
	REL 1-2		
	REL 2-1		Switching Relay 2
	REL 2-2		
	LS 1	Audio output with symmetrical 0.8 Watt/8 Ohm for loudspeakers	
	LS 2		
	AUDIO-ASYM	pre-amp output (asymmetrical) for an external amplifier	
	GND		
	AUDIO IN	Audio Input for MoH	

## Notes

Further installation and programming information of the K-Module 544 are available the installation instruction of the K-Module 544, Ref. Nor. 1101366.

# AS 43, AS 45, AS 200 IT

## System Interconnection

It is possible to interconnect 2 AS 45's or 2 AS 200 IT's and therefore increase the maximum number of port to 80. Of these 48 ports may be used for System Phones or System DECT's. The modules, with the exception of the LAN Module, may be inserted into any module slot of the interconnected telephone system. The following points with reference to the interconnection of two systems should be observed:

- If the telephone system is operated on a Point to Multi Point line, then a permanent active external S0 must be connected to the first S0 of the Master Cabinet.
- If the telephone system is operated on a Point to Point line, then at least one external S0 must be connected to the Master Cabinet.
- Like with the AS 45 up to 48 STE 30's or STE 40's may be connected.
- System programming will only be possible via the serial- or USB connection of the master cabinet. These connections are without function on the slave unit. Programming via the S0 Bus is possible on either cabinet.
- CTI via the serial- or the USB connection will only be available at the master cabinet. If you want to utilise CTI from various computers (Network), then a telephony server must be made available at the master system.
- Both system must be of the same firmware level. For this the master system must be updated, the slave system will automatically being updated.



**Master Connection:**  
The system on which this connection is used, is the MASTER SYSTEM (CABINET)

**Slave Connection:**  
The system on which this connection is used, is the SLAVE SYSTEM (CABINET)

- Disconnect both AS 45's or AS 200 IT's from the Mains Socket.
- Connect the "Master" socket from one system to the "Slave" socket of the other system. Please use a shielded network cable (at least CAT5). Please note that the length of this cable cannot exceed 1 metre.
- Power up both systems.
- Please wait until LED 4 is permanently lid. As before, you now can program the system via TK Suite.

# AS 43, AS 45, AS 200 IT

## Connecting a printer for printing connection charges

You can connect any printer to the telephone system's RS 232C interface to print out connection records. For connection, you need a cable that corresponds to the pin assignments given below (maximum length 3 m).

Your printer must be set as follows:

- 9600 baud
- 8 bits
- 1 stop bit
- no parity

To print out connection records, the printer must be on all the time and must be connected to the telephone system. The telephone system stores 2000 connection records and the total connection charges, even in the event of a power failure.

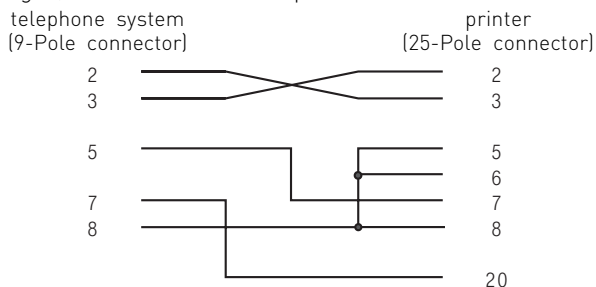

## Commissioning

You have installed the system. However, before you can make a call you must do the following:

- Connect the extensions. You may connect any apparatus which you are allowed to connect to the public switched telephone network.
- Connect the RJ 45 plug to the ISDN network or connect the relevant connection cable to the analogue network.
- Switch on the telephone system by plugging the mains plug into the mains socket.

Programming to the users requirement can be carried out via the connection of a PC. The remote programming of the system may be carried out via your dealer.

## Notes

To avoid calling wrong telephone numbers please ensure that the following is carried out. After installation of the system please dial from an analogue MF telephone a single digit, this ensures that the system recognises the correct dialling method for the relevant extension. Should you change to a telephone which is dialling in LD, then you must dial a digit higher than 2. Should you operate two telephone on one port, then you must ensure that both phones connected are of the same dialling method.

# AS 43, AS 45, AS 200 IT

## Technical Data

Specification	ModularISDN Telephone System with 5 Expansion Slots and On board Interconnection (AS 43: 3 Expansion Slots, no Interconnection)
Expansion Modules	
- K-Module 524	2 S0 connections switchable internal / external, 4 Analogue Extensions (POT's)
- S0-Module 540	4 S0 connections switchable internal / external
- T-Module 508	8 Analogue Extensions (POT's)
- AL-Module 4504	4 Analogue Trunk Lines
- Up0-Module 508	8 Up0 Ports
- K-Module 544	4 alarm input contacts, 3 Analogue Extensions or 1 FTZ 123D12 Door Phone, 1 two wire Door Phone and 1 analogue two wire doorphone (e.g. AGFEO TFE 2/4), 2 switching Relays, 1 audio output symmetrical for loudspeakers, switchable as pre-amp output (asymmetrical) for an external amplifier, 1 Audio Input for external MoH
Measurements	26 x 32 x 12 cm (High x Width x Depth)
Weight	3,4 kg
Ambient temperature	
- Operation/Storage	5 °C to 40 °C / -25 °C to +70 °C
Humidity	max. 70 % (none condensing)
Mains Connection	230 VAC, +6%/-10%, 50 Hz
Power Consumption	
- AS 45	$P_{\max} = 60 \text{ W}$
- AS 43	$P_{\max} = 40 \text{ W}$
External S0 Connection fixed	PTP or PTMP connections, Euro ISDN 2e
- Connection	via RJ 45 Socket and enclosed connection cable
Switchable Connection	S0 connection internal / external switchable (DIP Switches) external: PTP or PTMP connection Euro ISDN 2e (DSS1) internal: PTMP connection, Euro ISDN 2e (DSS1)

# AS 43, AS 45, AS 200 IT

## Technical Data

- Connection	4 wire spring loaded connectors
- Length	max length of internal SO Connection dependent on the mode - Short passive Bus 130 m - Extended passive Bus 1000 m
- Power Consumption internal SO	4,5 Watts
- ISDN-Apparatus	max. 8
Up0-Connection	
- Connection	2 wire spring loaded connectors
- Length	800 m
Analogue Apparatus	
- Distance	2 x 50 Ohm (diam. 0,6 mm, 800 m)
- Connection	2 wire spring loaded connectors
- Dial Method	DTMF or LD
- Enquiry Button	Flash (80 - 600 ms).
PC/ Printer Connection	RS 232C
- Range/Level	3 m / +/- 5 V
- Connector	9 pin D-Socket
USB Connection	Universal Serial Bus
- Cable Length	3 m
Switching Relays	Spare contact with surge arrestor 1 kOhm / 100 nF 30 VDC/1 A or 125 VAC/0.5A, resistive load
- Contact Load	1 kOhm, 100 nF
Audio Output	0,8 Watt /8 Ohm symmetrical 0,4 Watt /4 Ohm asymmetrical
Audio Input	Initial resistance 50 K Ohm



The crossed out wheeled bin on the product means that this belongs to the group of Electro- and electronic apparatus.

In this context you are directed by the European regulation to dispose of used apparatus

- at the point of buying an item of equal proportion / value
- at the local available collection point for disposal

With this you will participate in the reuse of material and valorisation of disused electric- and electronic apparatus, which otherwise could be a health hazard and be negative to the environment.



Ident no. 1101332  
Subject to change without  
notice. No liability can be  
accepted for errors contained in  
this document.  
Printed in Germany  
0067

**AGFEO** GmbH & Co. KG  
Gaswerkstr. 8  
D-33647 Bielefeld  
Internet: <http://www.agfeo.com>